

CEEC Sewage Tanker Truck

User's Manual



CEEC AUTO LIMITED

<http://www.cs-trucks.com>

Email: info@cectrucks.com tom@cectrucks.com

Vacuum Tank Truck



CEEC TRUCKS

Whatsapp: +86 136 4729 9000
+86 159 7192 0800

OWNER'S MANUAL

Preface

Thank you for purchasing CEEC TRUCKS products. For better using your ISUZU Sewage Tanker Truck, get the best operating performance, we strongly suggest that before the operation process you should read this manual instructions carefully, and to manipulate the program handily.

The manual detailed describes the performance of vacuum sewage truck, structure, usage, precautions and maintenance of such knowledge. While showing details of the truck, both pictures and description will together help you get better understanding of how to use truck. Before the operation, the skilled operator should carefully read the contents of the manual.

After master the truck performance characteristics, methods of operation and precautions, then could start to operate this sewage suction truck. In order to ensure the staff turnover after the operation, and properly use of the truck. This manual book must be properly kept, shall not be lost and damage.

CEEC TRUCKS

Whatsapp: +86 136 4729 9000
+86 159 7192 0800

---CEEC TRUCKS

Contents

Chapter 1. General Description	5
Chapter 2, Main Technical Data.....	6
i ,Road Sweeper Truck technical parameter	6
ii ,Sewage trucks application notice.....	7
Chapter 3, Sewage Truck Structure Components.....	8
i ,Sewage Truck Structure Components.....	8
Chapter 4, Vacuum Tanker Truck Working Principles	12
i ,How are the sewage trucks working?	12
ii ,What is the main component for truck?.....	12
iii, How to operate sewage trucks?.....	13
Chapter 5, Troubleshooting	15

Whatsapp: +86 136 4729 9000

+86 159 7192 0800

Chapter 1. General Description

CEEC TRUCKS Sewage Truck based on type II ISUZU 4*2 Left Hand Drive chassis, capacity for sewage tank can be up to 4000 liters, which also installed with best performed Chinese brand vacuum pump. The truck main consist of below system: PTO, Driving system, Vacuum pump system, Durable vacuum tank system, High pressure working system, Pipeline system, Vacuum gauge, View window, Washing system, etc.

The vehicle designed to fully rely on the advantages of the original of ISUZU brand chassis, fully consider the product's convenience and reliability, also the chassis ISUZU technology features. The vacuum tanker truck has advantage of big capacity and suction efficiently, and maintenance for whole truck can be easily. The tank material is international standard strength carbon steel, which treated with antirust painting both inside and outside.

The ISUZU 4x2 Vacuum Sewage Truck is ideal and special-purpose machinery used for dredging city sewer, specially applied to pumping, cleaning and transporting the sewage sludge, also can be used for suction droppings and some other works. The truck is widely used for all kinds of suction work in city, high-way service station, airport, community, factory, etc. Therefore, the vehicle is an ideal Vacuum Truck mainly for liquid sewage suction.



(Preview for your ISUZU Vacuum Tanker Truck)

Chapter 2, Main Technical Data

i ,Road Sweeper Truck technical parameter

Items		4,000 Liters ISUZU Sewage Truck
S I Z E	Outer Dimension (L×W×H) (mm)	5800x1900x2500
	Wheelbase (mm)	3360
Kerb Weight (kg)		3500
G E A R	Gearbox brand	ISUZU MSB
	Model	5-shift gearbox
	Type	Manual
Cab capacity (includes driver)		2
E N G I N	Brand	ISUZU
	Model	4JB1CN
	Type	Four cylinder inline, four stroke, water-cool, turbocharged Inter-cooling, diesel
	Rating Power (kW/HP)	72 / 98

Note: 1. The vehicle height includes Rear Climbing Ladder.

2. We keep the right to revise the parameters on the list above.

Whatsapp: +86 136 4729 9000

Sewage Suction System basic parameter list 86 136 7192 0800

Items		Parameter
Superstructure	Dirty water tank	4000 Liters
	Material	Carbon steel, 5mm thick
	Design pressure	Full Vacuum – 0.9bar
	Vacuum pump	China famous WEILONG
	Suction Pipeline	PVC hose with 4" diameter
	Full-suction time	≤5min
	Discharge valve	6" discharge valves
	Rear cover	Hydraulic open and Manual locking

ii ,Sewage trucks application notice

(1) *Keep the vacuum pump at suitable revolution speed:*

If the pump too speedy, the rotor's temperature will be very high; on the contrary, the pump too slowly, engine knock will happen, which will impact the parts and affect the service life. In one word, the proper revolution speed is necessary, and should have the HAND THROTTLE to the largest adjustment position in advance.

(2) *Rollover the tanker on flat road*

Rollover the tanker on the tilt road will not only make parts distortion and lead to malfunction, but also an accident.

(3) *Open rear door before rollover the tanker*

Open rear door before rollover the tanker is very important, or there may be an accident.

(4) *When clutch pump and vacuum pump take power form PTO, have the engine idling, and completely press the clutch pedal, then slowly lift the clutch pedal.*

(5) *NOTES: Keep the PTO box's joysticks in middle position while driving.*

(6) *Waste oil and other danger things are not allowed to be carried by this vehicle.*

(7) *The supporting rods and safety stop must be used while tanker is raising position before entering the base or repairing the tanker.*

Whatsapp: +86 136 4729 9000

+86 159 7192 0800

(8) *When transporting sewage, the manual rear door clamping device must be used to keep safety. For there are no water cutter and the high barycenter, the vehicle also must drive at middle or low speed, and must not turning and braking suddenly.*

Chapter 3, Sewage Truck Structure Components

i ,Sewage Truck Structure Components

Overview for ISUZU Vacuum sewage truck technical drawing:

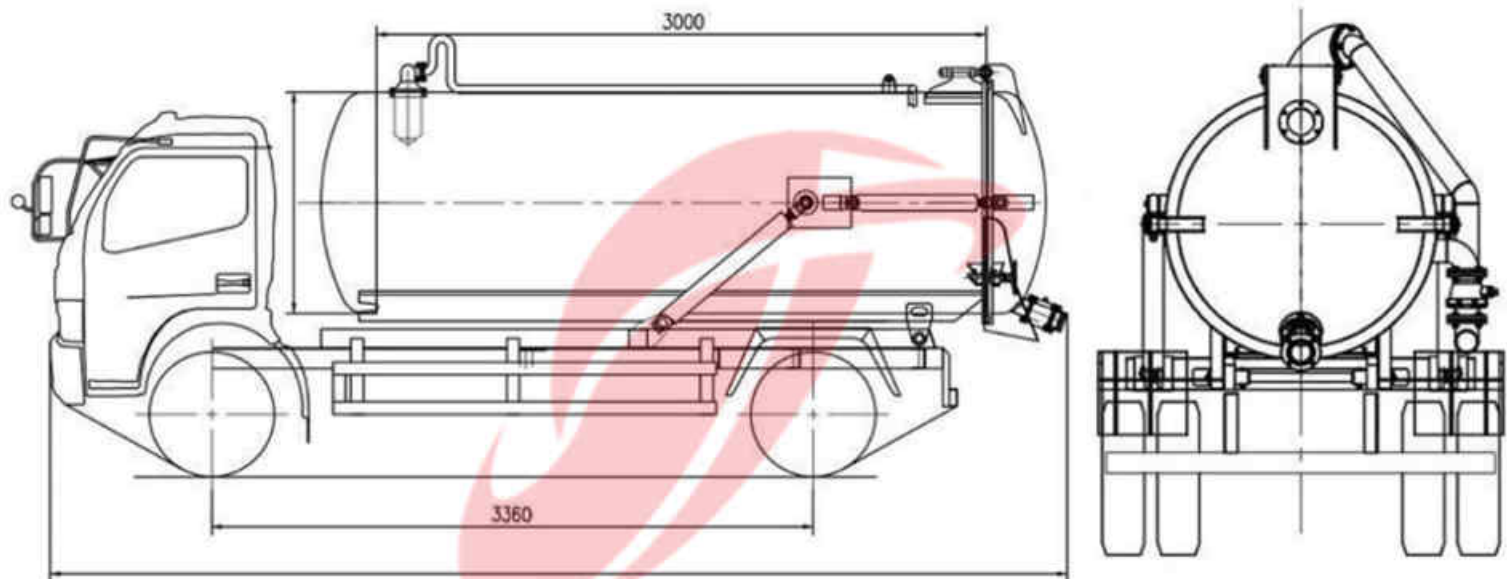

MAIN PARTS: 1, air operated valve

2, PTO box joysticks

3, vacuum pump

4, manual operated valve

5, four-way valve

6, oil-gas separator

7, rollover oil tanker

8, suction valve

9, open-door cylinder

10, discharge valve

11, rear door clamping device

12, scupper valve

13, suction soft pipe

14, safety alarm

Above drawing show detailed parts for this ISUZU sewage suction truck, which use original ISUZU type 2 chassis, with white color single row cabin, wheelbase 3360mm, 4JB1CN engine with 98PS, detailed picture for chassis as below:

Pictures show customer required chassis for record



Vacuum Pump: famous Chinese brand WEILONG vacuum pump, which installed below of the tanker system

Vacuum Pump System below of tanker



Whatsapp: +86 136 4729 9000
+86 159 7192 0800

Manual Operated Valve: equipped at side of the platform, which control the vacuum tank rise / fall, and rear door open / close.

Manual Operated Valve

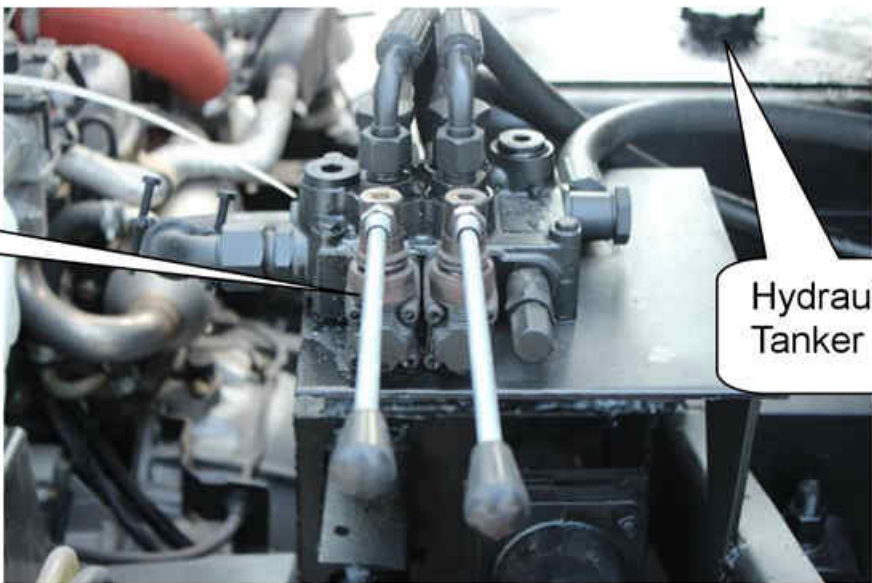

Hydraulic Oil Tanker

Vacuum System: equipped with Four-Way Valve, First Level Oil-Gas Separator, Second Level Oil-Gas Separator, Water-Gas Separator.

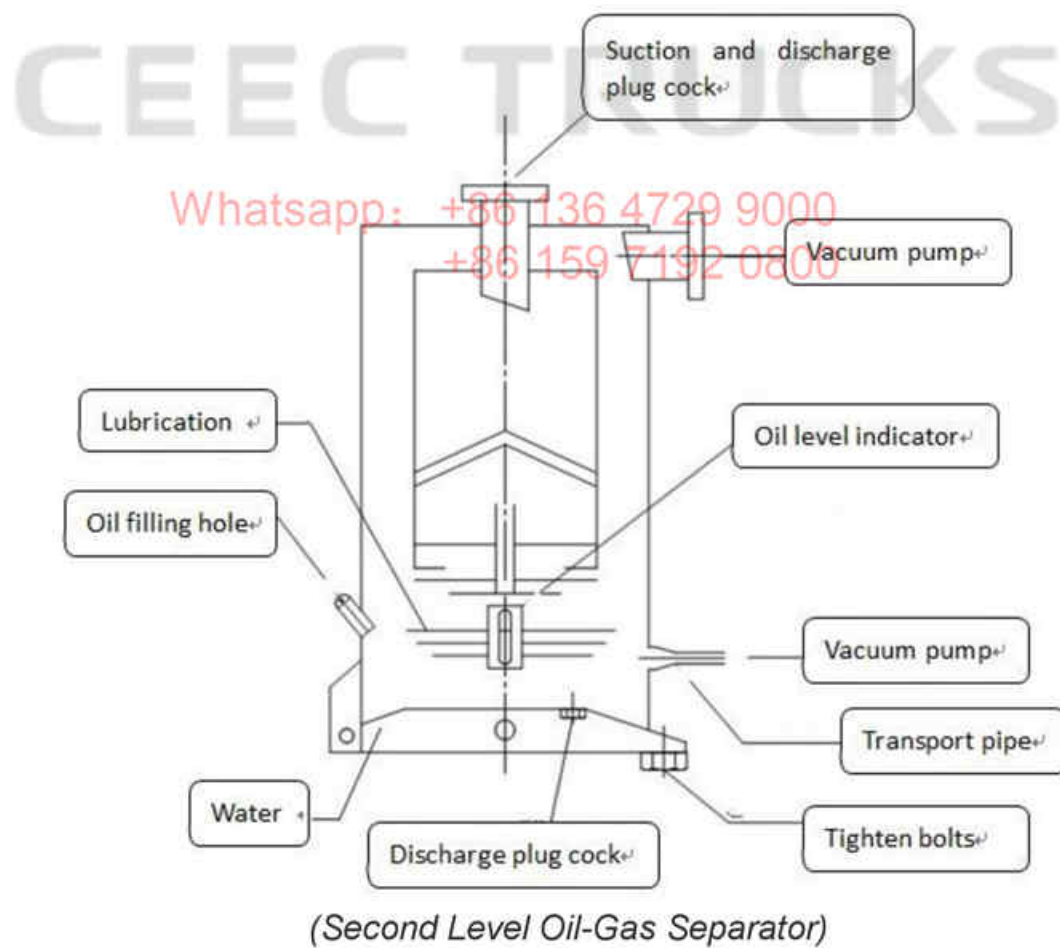
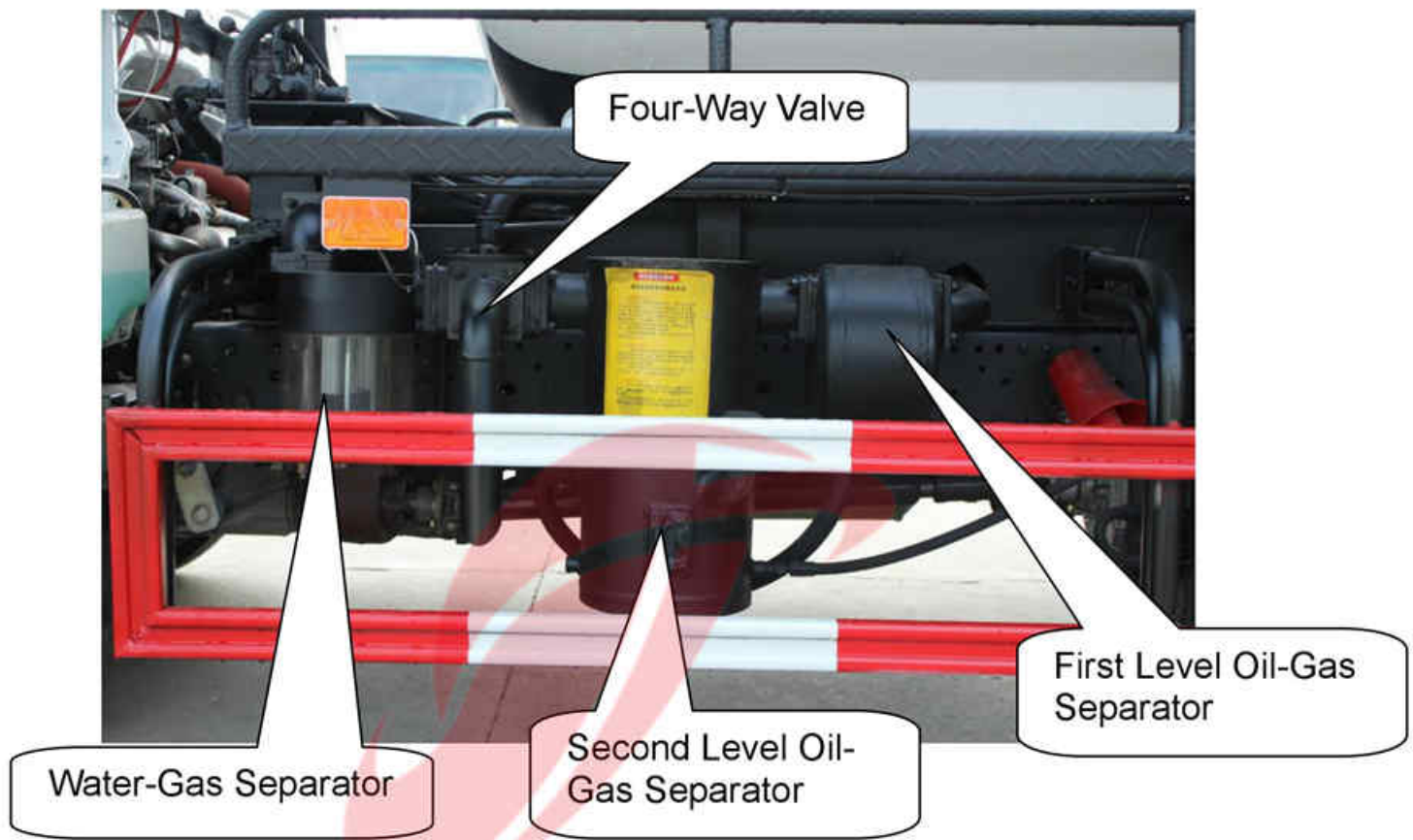

(Second Level Oil-Gas Separator)

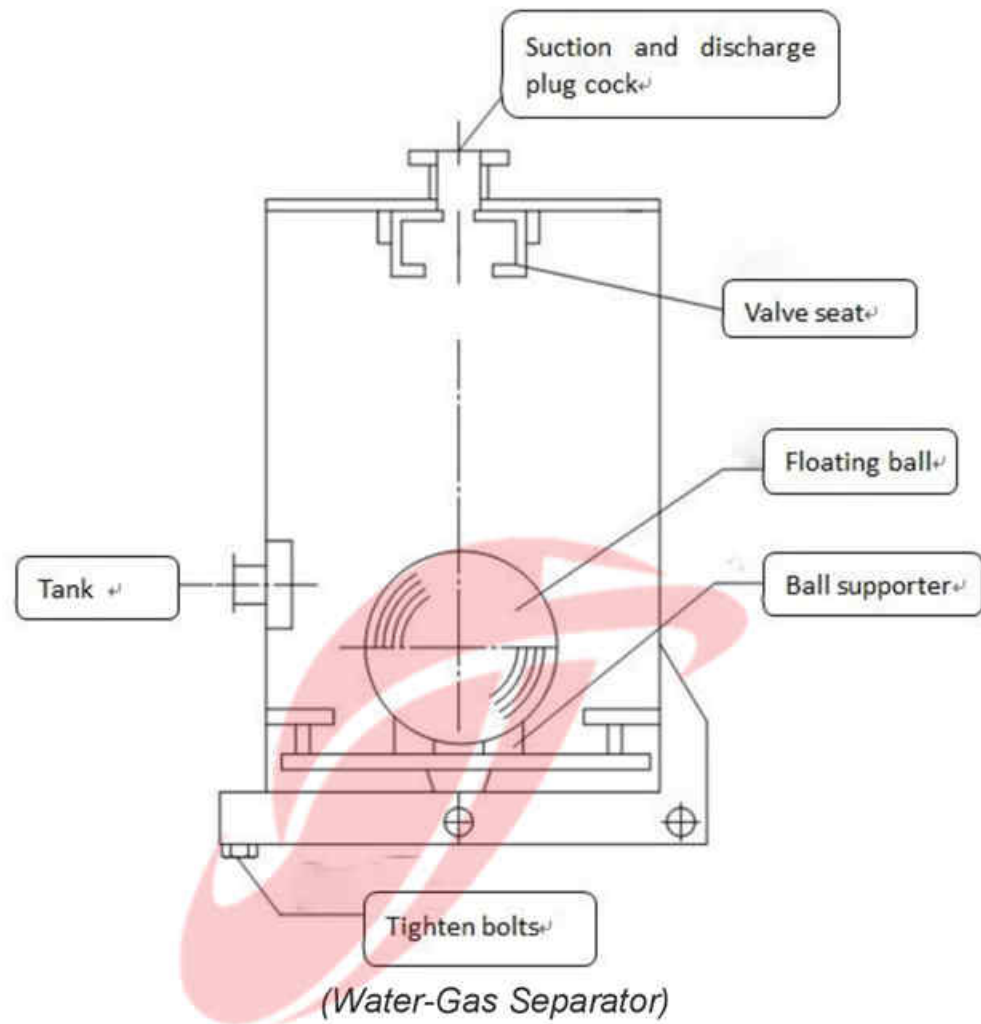

Whole view of the Truck Tanker:

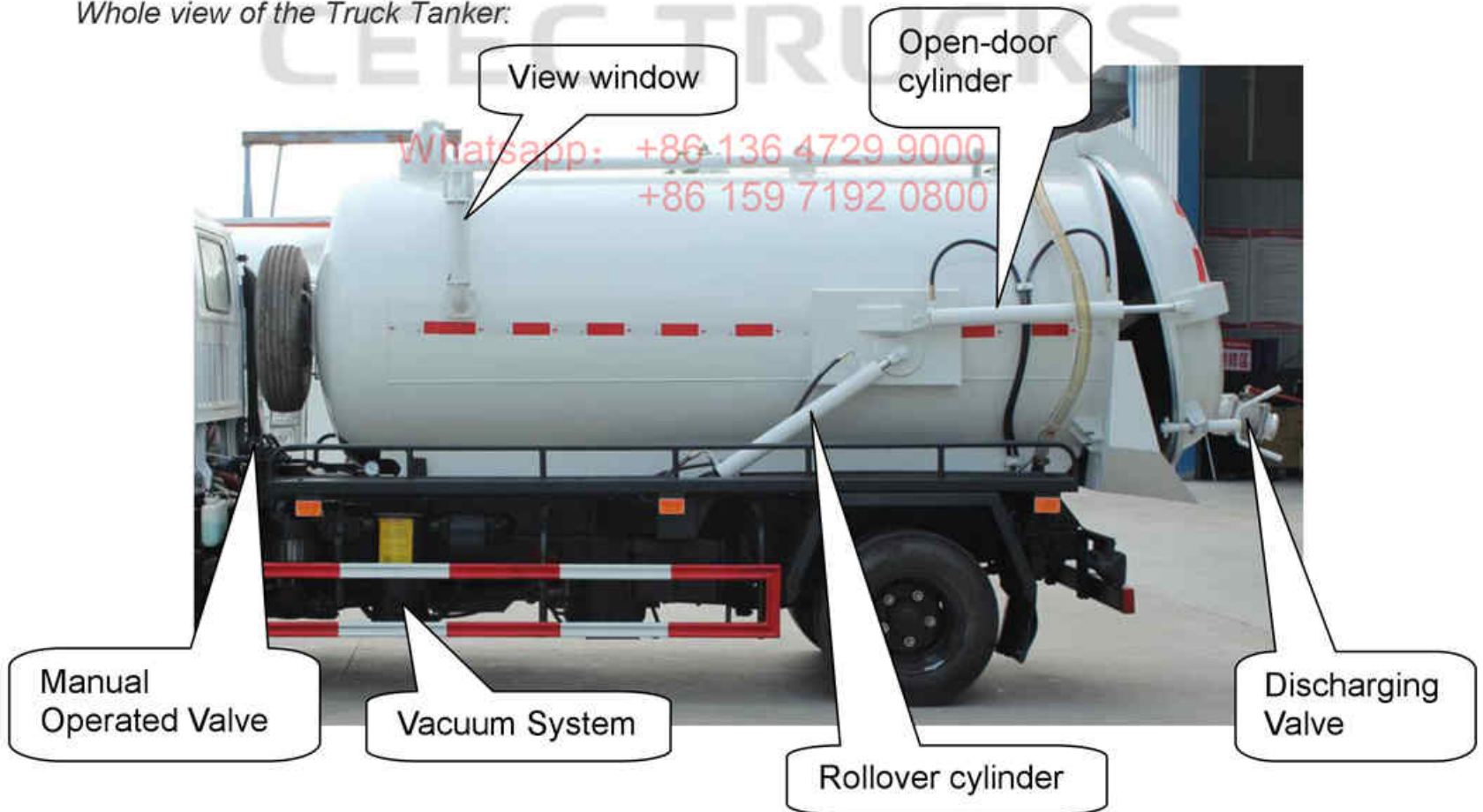

Chapter 4, Vacuum Tanker Truck Working Principles

The operator should fully understand Whole Structure and Working Principle for ISUZU Sewage Truck before any operation. Only trained person can operate this vehicle properly and to prevent unnecessary accidents and equipment damage.

i ,How are the sewage trucks working?

The ISUZU Sewage Truck makes use of the PTO to get the power from truck engine, and the power drive the vacuum system working. Operation the valves to control the truck suction liquid sewage, adjust the throttle knob to make suction speed faster and slowly. After suction working, using Manual Operated Valves to control rear door Open/Close, and sewage tanker Rise/Fall. After working, cleaning the sewage tank, and ready for next time operation.

ii ,What is the main component for truck?

The sewage truck is refitted based on the ISUZU 4x2 LHD chassis. The refit part includes Vacuum suction assembly, actuator device and operation system.

- *Vacuum suction assembly: One round shape vacuum sewage tank. 1 unit suction pipeline, whole suction system.*
- *Actuator device: includes PTO, drive line, etc., which can pass the power to the pump.*
- *Operation system: helps come to all special functions' convert.*

iii, How to operate sewage trucks?

(1) Suction operation preparation

- A, Keep the sewage tank rear door closed
- B, Carefully check whether the lubrication of vacuum pump gas-oil separator working normally.

(2) Operations sequence (Detail figure)

- A, Press the clutch pedal, adjust the PTO box joystick, to get power from the truck engine and start the vacuum pump, then slowly release the pedal.
- B, Start the safety alarm (in the cab)
- C, Adjust the hand throttle joystick to largest position, and keep the revolution meter point to 500-600r/min (already has been set before out the factory)
- D, Adjust the four-way valve joystick to suction position, carefully check the released air, the vacuum pump sound, the vacuum meter.
- E, Put the suction pipe into the sewage. Park the vehicle in right place before suction working, which can keep the pipe straight or free bending state, and guarantee vehicle work normally.

(3) Attention while working

- A, Things like over 50mm stone, cotton yarn, leaves etc. will block the suction pipe, and should not be suction, also should keep the pipe clean and unblocked.
- B, Keep the suction valve full open while vacuum meter point to 65-80kpa, because half-open may damage the valve.
- C, The suction pipe should be moved frequently while suction. Because suction some air and water will increase efficiency when the sewage is too viscosity.

3, Waste water discharge operating instruction.

After sludge and waste water separate, open scupper valve to discharge all the waste water and be ready for next suction. Pressure can bigger while discharging water. Operation approach as follows:

- A, Adjust four-way valve joystick to neutral position, then open the scupper valve to open position, and discharge all the waste water by gravity.
- B, Adjust four-way valve joystick to discharge position, then the vacuum pump keep working, and the pressed air goes into tanker to put waste water quickly out of the tanker.
- C, When discharge by pressure, firstly, open the discharge valve, then adjust discharge valve

joystick to discharge position, in case of tanker pressure become too high, some accident and bad influence on rear door sealing.

4, Muddy discharge operating instruction

(1) Press the clutch; turn on the air operated valve (FAW brand) or adjust PTO box joystick (Dong Feng brand) to make oil pump running.

(2) Rear door clamping device valve to discharge some waste water, and adjust the inside tank pressure to be equal to the outside pressure.

(3) Open the rear door clamping device, loosen the handgrip and completely take off screw.

(4) Adjust the rear door manual operated valve to open position, please be sure the inside and outside air pressure is equal before open the door. If the pressure is not equal, the door seal and oil cylinder may be damaged.

(5) Adjust manual operated valve joystick to UP position

(6) Recovery operation after discharge the sludge: adjust manual operated valve joystick to DOWN position, and carefully exam the follow things after the tanker reposition.

A, Carefully check the tank door flange and seal ring, and clean it if dirty.

B, Adjust manual operated valve joystick to CLOSE position, closes the rear door.

C, Operating the rear door clamping device until the rear door closed completely.

CEEC TRUCKS

Whatsapp: +86 136 4729 9000
+86 159 7192 0800

Chapter 5, Troubleshooting

After carefully reading the above information, you must be well known how to use the ISUZU Sewage Truck; below show some important parts to help solve problems.

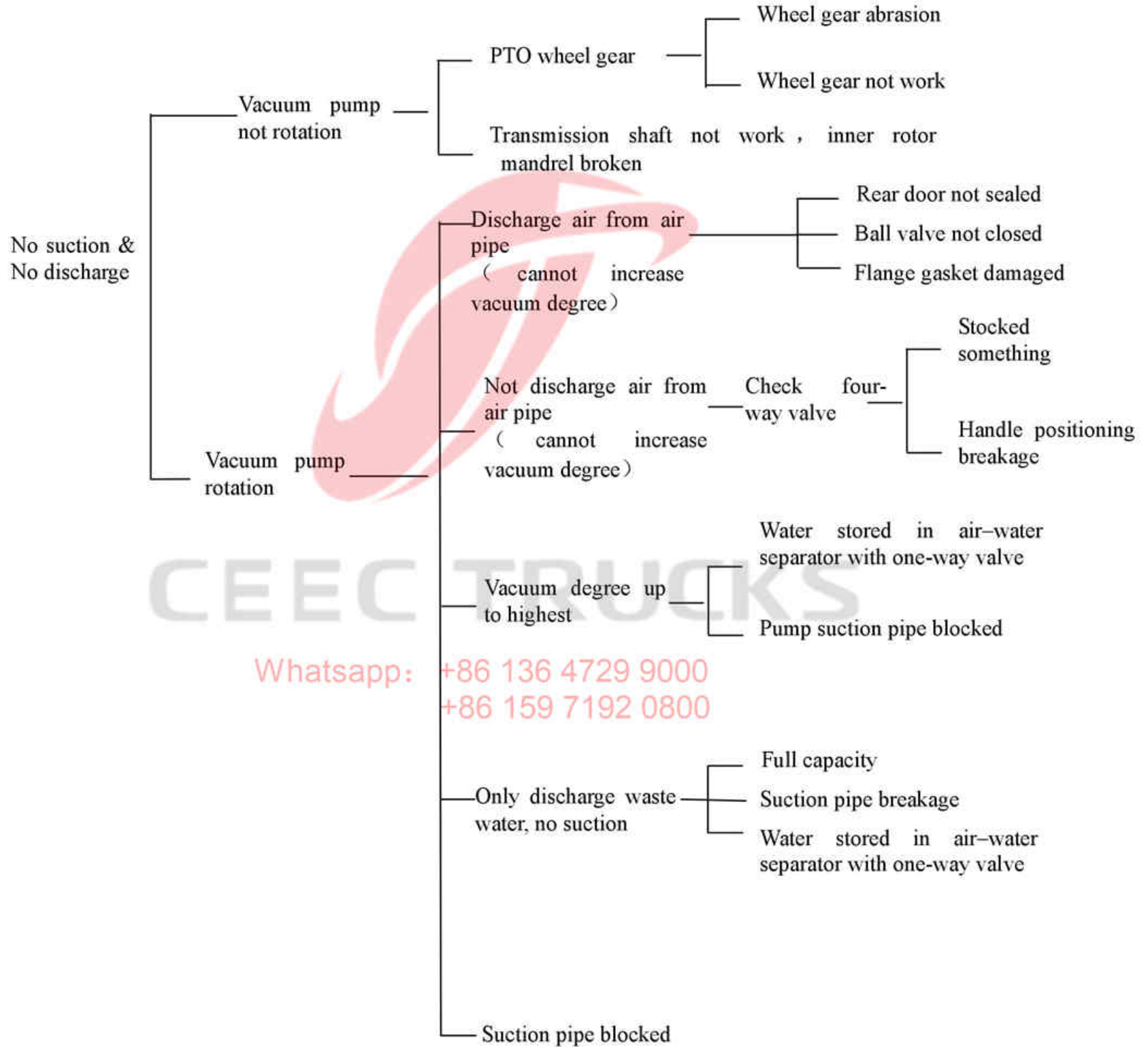

Whatsapp: +86 136 4729 9000
+86 159 7192 0800